

finebeam

Finebeam Dual

Q-Switched & Long-Pulsed
Nd:YAG Laser

Finebeam Qplus

Q-Switched Nd:YAG Laser

Competitive

THREE DIFFERENT PULSES

in One Platform

(Q-Switched, Long-Pulsed, Quasi)

Clinically Proven **LIOB**

for Skin Rejuvenation

(Laser-Induced Optical Breakdown)



MEDICAL & AESTHETIC
SOLUTIONS



01

Finebeam Dual

Q-Switched & Long-Pulsed
Nd:YAG Laser

Main Benefits

- **True Long-Pulsed** mode provides **Ultimate Genesis Toning Effect**
- **LIOB Effect** by installing **MLA Handpiece** thanks to the strong and stable power supply
- **Exceptional High Power in PDP Modes** enables to **Gently** treat the **Deeper Lying Skin Pigment** without adjacent tissue damage
- **Longer Life Time, Lower Maintenance Cost, Strong and Stable Power** supply with **Two Chambers**
- **High Cost Efficiency** with one laser system with three modes and maximize **Space Utility**

True Genesis Toning Effect with True Long-Pulsed Laser

No Cooling, No Pain, No Side Effect
Absolute Complete Comfortable Warm Feeling

Finebeam Long-Pulsed laser provides **True Genesis Toning Effect** which can't be realized with Q-Switched Quasi mode. The periodical and continuous genesis toning restore youthful skin so it is recommended as **LIFE CARE**.

Genesis Technique is the Way to Activate the Fibroblast of Papillary Dermis

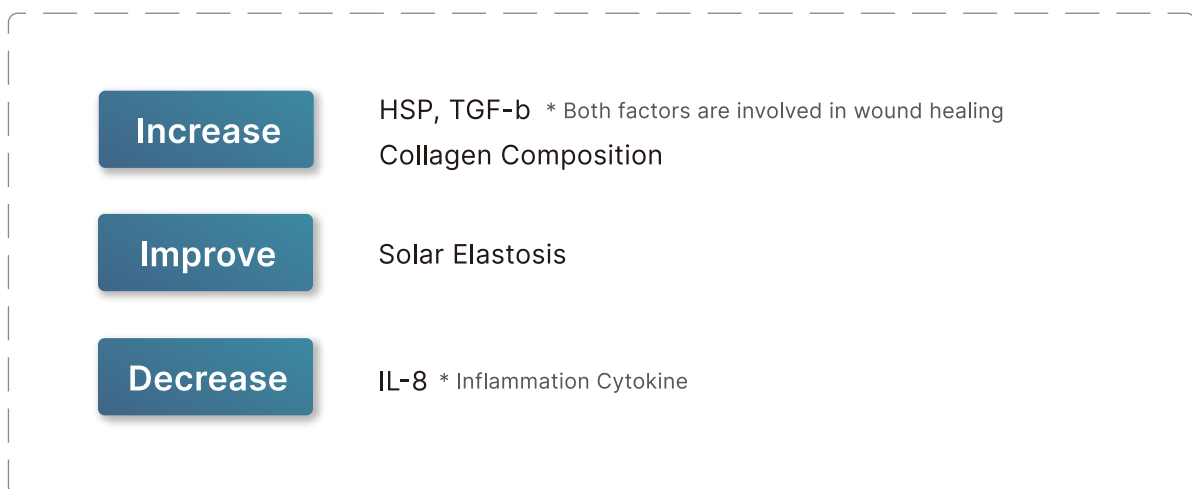

Effective for

- Whitening:** Melasma and other pigments associated solar elastosis caused by long term UV exposure
- Tightening:** Skin Texture, Pore Size, Wrinkle

Finebeam Zoom MLA Handpiece (Micro Lens Array)

Realize LIOB adopting MLA handpiece for optimal skin regeneration effect

It collects the laser beam through the lens, the character of the laser beam is maintained, and it makes a gaussian distribution curve like the energy in the center is high and around it is low. MLA delivers high energy in the center.

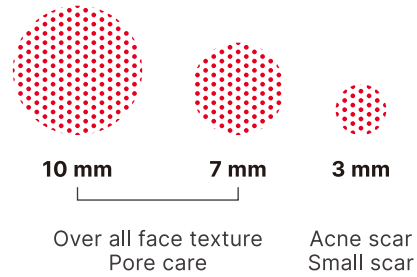
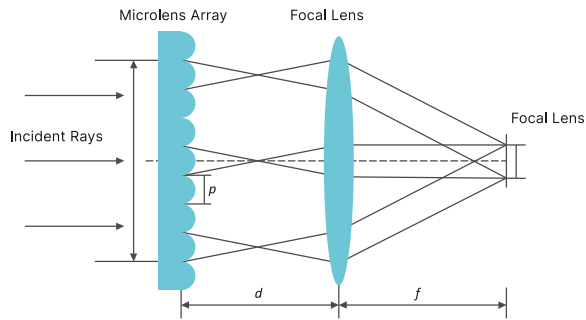

Clinically Proven LIOB Effect for Skin Rejuvenation

Histology Picture Tested by Finebeam

Courtesy of J.B. Lee M.D

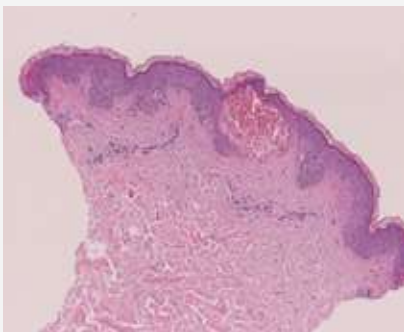

100x

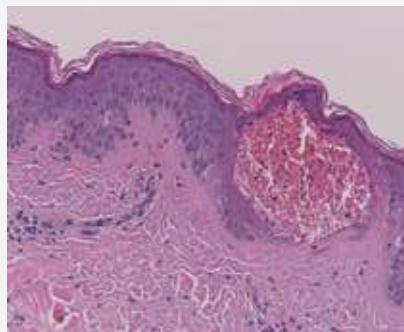

200x

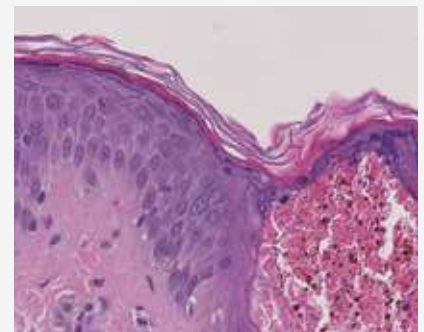

400x

LIOB Mechanism

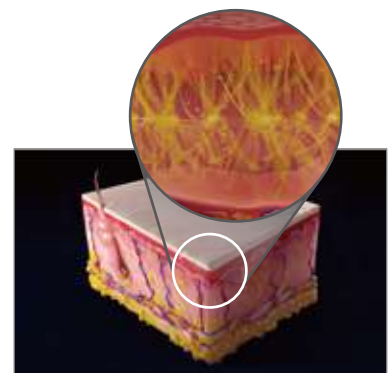
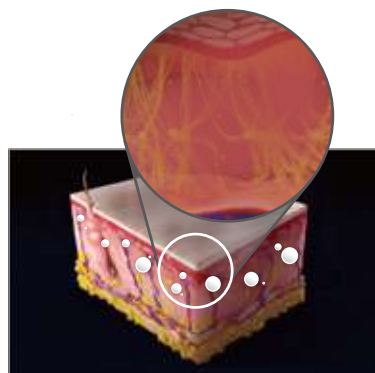

Specifically Designed Finebeam Zoom MLA Handpiece

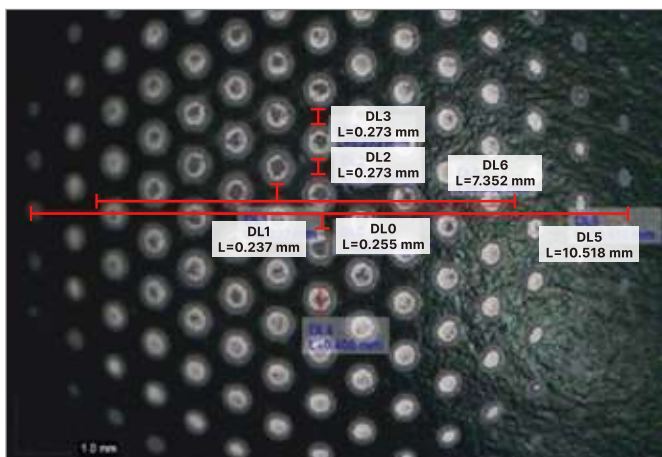

MLA handpiece is equipped with **120 Micro Lenses**. The beam from the MLA handpiece has 100 **Effective Spots for 10mm Spot Size**, they keep a certain distance of about **0.25~0.3mm** so it will show consistently good performance without side effects.



- Finebeam MLA Handpiece -

Using more advanced resonator technology and a specially designed arm, there is almost no energy loss passing the laser arm from a resonator to the end of the arm. Almost 100% energy delivery to the handpiece realize the defined LIOB effect.

Optimal Results in All Indications Related with Skin Regeneration

Acne Scar, Pore Size, Skin Laxity, Skin Texture, Fine Wrinkles, Dermal Pigments etc.

Male / Ice Pick Scar, Acne Scar



Before

1 Sessions After

Female / Scar



Before

4 Sessions After

Courtesy of Y.H. Hwang M.D

Finebeam DOE Handpiece (Diffractive Optic Element)

Realize the ultimate safe and effectiveness of pigmented lesions

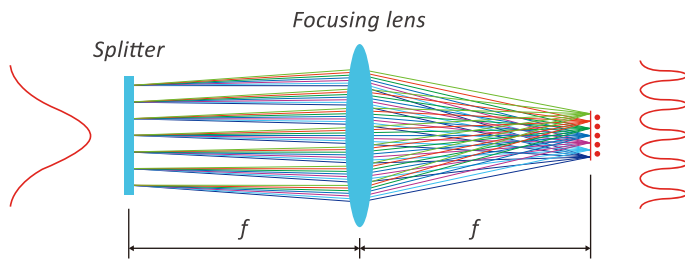

It has to Top-hat beam profile and emits a uniform fractional beam. So it can give predictable results to treat pigmented lesions. DOE is a very effective method for removing pigmentation while minimizing the risk of side effects and downtime.

Special Indications for DOE:

toning for sensitive skin, easy pigmentation rebound skin and thermal sensitive skin, seborrheic dermatitis, pigmented lesions



Female / Pigmentation care, Skin tone

Courtesy of DR. JYOTI V. (From India)



Before

After

Male / Skin tone



Before

Right After Treatment
(a little bit erythema only)

2 Weeks After

Finebeam Exceptional High 2.2J PDP Mode

High power of PDP mode gently and powerfully treats dermis pigments

Finebeam PDP mode peak power is 2.2J, it is around 10 to 30% higher than others.

To break melanin in the dermis, if an operator increases power only with the single-mode, laser reacts with the melanin in the epidermis before reaching the dermis or it can be the cause of epidermal skin trouble like hypopigmentation or folliculitis, etc. In PDP mode by dividing the pulse with two, up to high power 2.2J energy can safely and effectively be delivered to the dermis without skin damage.

Even though dividing with two pulses, peak power for one pulse is still high as 1.1J, the high power can generate a photoacoustic effect enough to break melanin and tattoo ink, etc in the dermis.

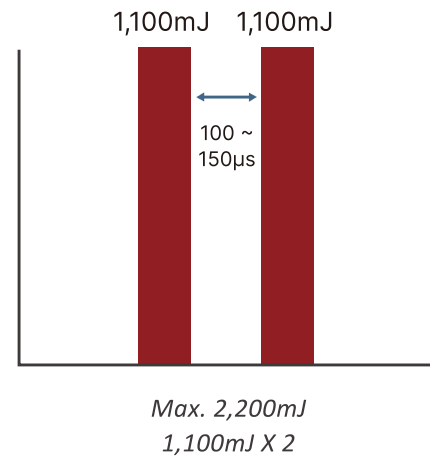

Female / Melasma & ABNOM

Courtesy of Y.H. Hwang M.D



Before

10 Sessions After

Female / Melasma & Skin tone & Blemish

Courtesy of Minh (From Vietnam)



Before

After

After several treatments with a single pulse, when you can't see the improvement anymore and you can see the light pigment in the dermis, it is the right time to treat with PDP mode.

Optimal Results for Pigment in Dermis

Melasma, Abnom, Tattoo etc.

Finebeam Exceptional High 2.2J PDP Mode

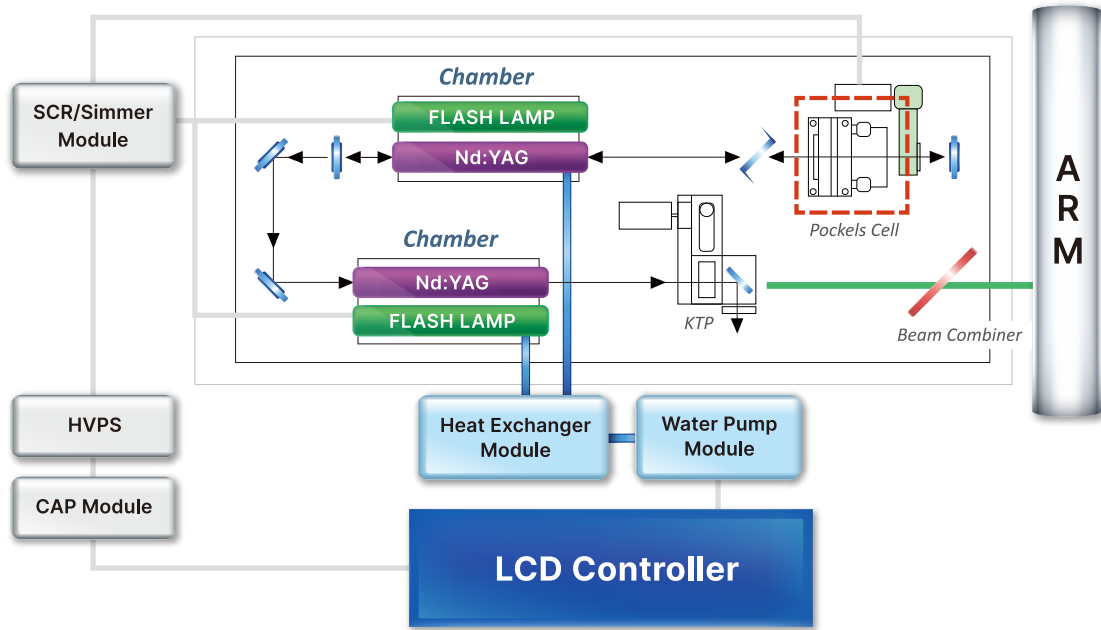

- Finebeam Two Chambers Laser Head -

Hair Removal (LPS)

Courtesy of Y.H. Hwang M.D



Before

After

Telangiectasia (LPS)

From Indonesia



Before

After

Finebeam Dual Cover Wide Range of Indications

With Three Different Pulse Durations; Nanosecond (Q-Switched), Microsecond (Quasi), Millisecond (Long-Pulsed)

The three different pulse durations offer optimal results by a combination of different pulse treatments and smart different layers approaches.

- **Dual Toning**

Toning with Q-Switched → Genesis Toning with Long-Pulsed

- **Tri Full Toning**

Toning with Q-Switched → Genesis Toning with Long-Pulsed
→ MLA with Q-Switched



High Cost Effectiveness High Space Utilization

It allows high cost-effective by the versatile indications as well as improving space utilization.

4 Different Range of Wavelengths Target a Various Type of Pigment

Zoom handpiece is generally used for all type of pigments. And our various types of handpiece enhances the treatment efficacy and safety.

595nm Gold is for vascular melasma, 650nm Ruby is for rosacea and fine blood vessels.



1064 & 532
Zoom Collimation

1064 DOE QSW

1064 Zoom
MLA QSW





650nm Ruby

595nm Gold

Safe and Convenient Automatic 'Handpiece Type' and 'Spot Size' Detection Function

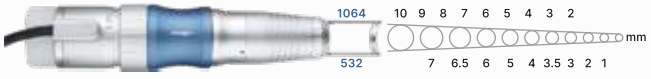
- Standard supplied Zoom Collimation handpiece keeps the same spot size and power up to 10 cm distance from the skin, it makes capable of non-contact treatment without additional purchasing of Collimation handpiece.
- Various type of handpiece enhances the synergy effect with combination treatment.

6 different types of Handpiece Helps for Achieving Desired Clinical Results

| | |
|---|-----------------------|
| <p>Zoom Collimation * All Applications in General (Toning, Carbon Peeling etc.) QSW & LPS 1064 : 2~10mm / 532: 1~7mm</p>  <p>▶ Standard</p> | C O L L I |
| <p>DOE * Pigment Care QSW 1064 : 7mm</p>  <p>▶ Option</p> | F R X |
| <p>Zoom MLA * Elasticity Related Care QSW 1064 : 10, 7, 4mm</p>  <p>▶ Option</p> | F R X |
| <p>650nm Ruby * Rosacea, Fine blood vessel, Green tattoo QSW 1064 : 3mm</p>  <p>▶ Option</p> | D Y E |
| <p>595nm Gold * Vascular melasma, Rosacea, purple, Sky blue tattoo QSW 1064 : 5mm</p>  <p>▶ Option</p> | D Y E |

Technical Specification

| Product Name | Finebeam Qplus | Finebeam Dual |
|-----------------------------|--|-----------------------------|
| Pulse Energy (Max) | 1064 Q Single: 100~1300mJ | 1064 Q Single: 100~1600mJ |
| | 1064 Q Double: 500~2000mJ | 1064 Q Double: 500~2200mJ |
| | 532 Q Single: 20~500mJ | 532 Q Single: 20~500mJ |
| | 1064 Quasi-Long: 100~3000mJ | 1064 Quasi-Long: 100~3500mJ |
| | | 1064 Long: 1~60J |
| Laser Type | Q-Switched & Long-Pulsed Nd:YAG Laser | |
| Wavelength | 1064/532nm | |
| Pulse Duration | 1064 Single < 10ns | |
| | 532 Single < 10ns | |
| | Quasi < 350µs | |
| | 1064 PDP < 20ns | |
| | 1064 Long-Pulsed < 0.3~300ms | |
| Repetition Rate | Single, 1~10Hz | |
| Beam Delivery System | Articulated Arm with Handpiece (7 Joint) | |
| Aiming Beam | Laser Diode, 3mW Pilot Beam (655nm) | |
| Cooling System | Internal Water to Air Heat Exchanger | |
| Electrical Power | 100~240VAC, 50/60Hz | |
| Dimension | 320(W) x 850(L) x 800(H) mm | |
| Weight | 70kg | 75kg |

INDICATIONS

Q-Switched :

Melasma & PIH Improvement, Nevus of Ota & ABNOM Removal, Soft Peeling, Tattoo Removal, Freckle, Lentigines, Café-au-lait Spot, Becker's-Nevus, Age Spot Improvement etc.

Long-Pulsed :

Genesis, Skin Tightening & Lifting, Acne Erythema Improvement, Telangiectasia, Hair Removal etc.



finebeam

True Genesis
Long-Pulsed

MLA LIQB
EFFECT
Strong and Stable Power

High Power Effective
PDP Pigment
Care

**Two
Chambers** High Durability
Stable Power

DOE Ensure
safety
Pigmentation Care



▼ Connect with SNJ Medical

SNJ Co., Ltd No. 608, Ace-Techno Tower 2, Digital-ro 31-gil 19, Guro-gu, Seoul, Korea
Tel : 82-2-866-9005 | Fax : 82-70-8622-9009 | E-mail : overseas@medicalsnoj.com

 SNJ  medicalsnj  SNJ Medical

